

SKY RESIDENCES  
**RESIDENCES 08**  
 LEVEL 46

1 BEDROOM  
 1.5 BATHROOMS

INTERIOR: 997 SQ. FT. 92 SQ. M.  
 EXTERIOR: 202 SQ. FT. 19 SQ. M.  
 TOTAL: 1,199 SQ. FT. 111 SQ. M.



ASTON MARTIN

RESIDENCES

at  
 300 BISCAYNE BOULEVARD WAY  
 MIAMI

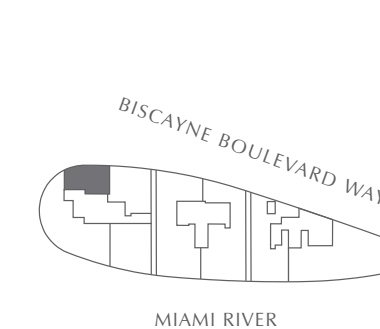
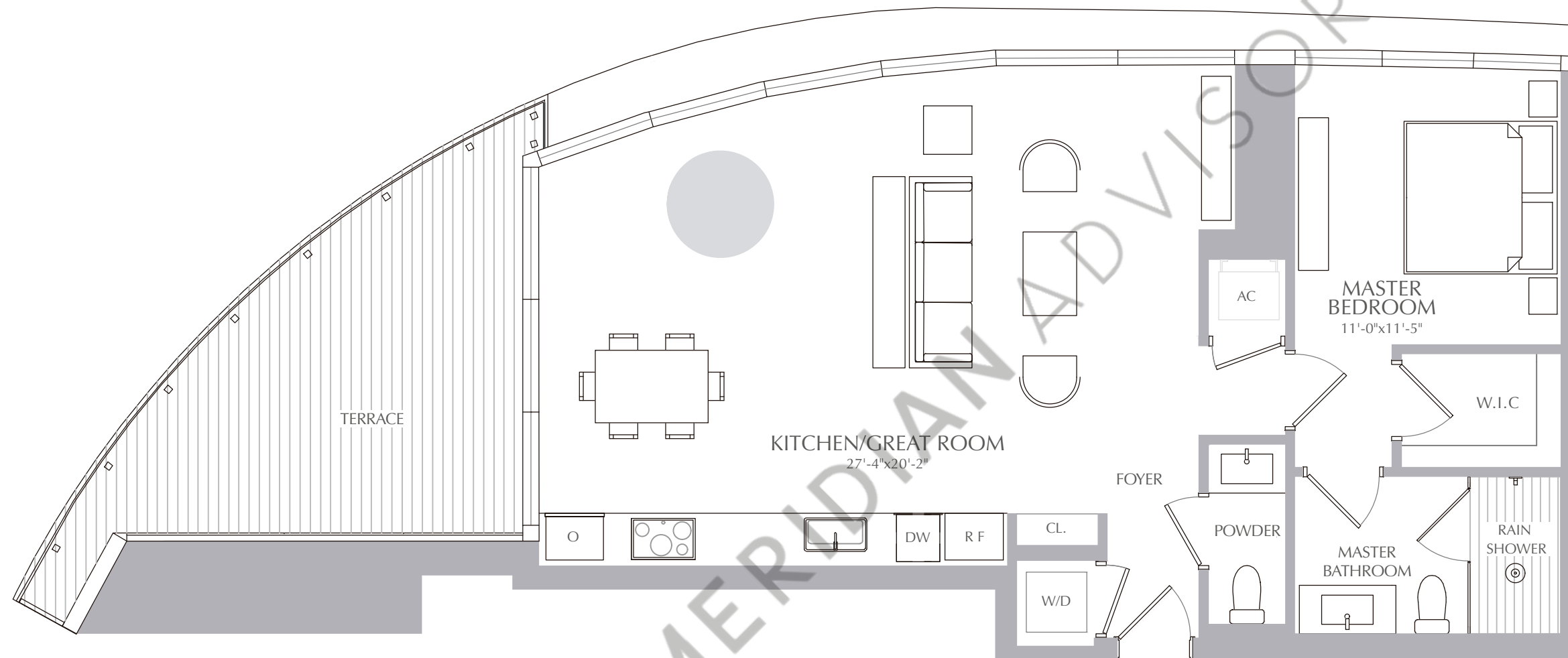
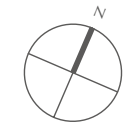

ORAL REPRESENTATIONS CANNOT BE RELIED UPON AS CORRECTLY STATING THE REPRESENTATIONS OF THE DEVELOPER. FOR CORRECT REPRESENTATIONS, MAKE REFERENCE TO THIS BROCHURE AND TO THE DOCUMENTS REQUIRED BY SECTION 718.503, FLORIDA STATUTES, TO BE FURNISHED BY A DEVELOPER TO A BUYER OR LESSEE. THESE MATERIALS ARE NOT INTENDED TO BE AN OFFER TO SELL, OR SOLICITATION TO BUY A UNIT IN THE CONDOMINIUM. SUCH AN OFFERING SHALL ONLY BE MADE PURSUANT TO THE PROSPECTUS (OFFERING CIRCULAR) FOR THE CONDOMINIUM AND NO STATEMENTS SHOULD BE RELIED UPON UNLESS MADE IN THE PROSPECTUS OR IN THE APPLICABLE PURCHASE AGREEMENT. IN NO EVENT SHALL ANY SOLICITATION, OFFER OR SALE OF A UNIT IN THE CONDOMINIUM BE MADE IN, OR TO RESIDENTS OF, ANY STATE OR COUNTRY IN WHICH SUCH ACTIVITY WOULD BE UNLAWFUL. Stated square footages and dimensions are measured to the exterior boundaries of the exterior walls and the centerline of interior demising walls and in fact vary from the square footage and dimensions that would be determined by using the description and definition of the "Unit" set forth in the declaration (which generally only includes the interior airspace between the perimeter walls and excludes all interior structural components and other common elements). This method is generally used in sales materials and is provided to allow a prospective buyer to compare the units with units in other condominium projects that utilize the same method. For your reference, the area of the unit, determined in accordance with these defined unit boundaries, is set forth in exhibit "3" to the declaration. Measurements of rooms set forth on this floor plan are generally taken at the farthest points of each given room (as if the room were a perfect rectangle), without regard for any cutouts or variations. Accordingly, the area of the actual room will typically be smaller than the product obtained by multiplying the stated length and width. All dimensions are estimates which will vary with actual construction, and all floor plans, specifications and other development plans are subject to change and will not necessarily accurately reflect the final plans and specifications for the development. All depictions of appliances, counters, soffits, floor coverings and other matters of detail, including, without limitation, items of finish and decoration, are conceptual only and are not necessarily included in each unit.

SKY RESIDENCES  
**RESIDENCES 08**  
 LEVEL 47

1 BEDROOM  
 1.5 BATHROOMS

INTERIOR: 985 SQ. FT. 92 SQ. M.  
 EXTERIOR: 174 SQ. FT. 16 SQ. M.  
 TOTAL: 1,159 SQ. FT. 108 SQ. M.



ASTON MARTIN

RESIDENCES

at  
 300 BISCAYNE BOULEVARD WAY  
 MIAMI

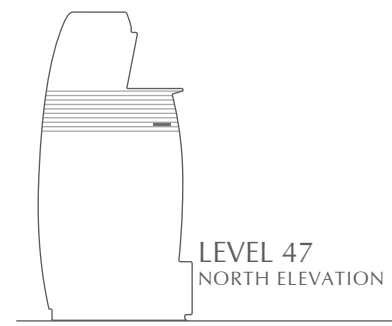
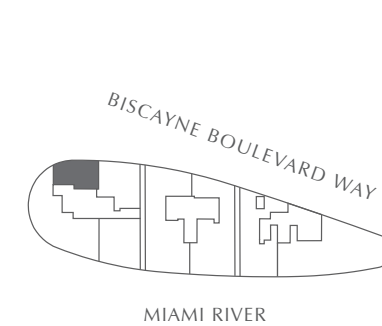
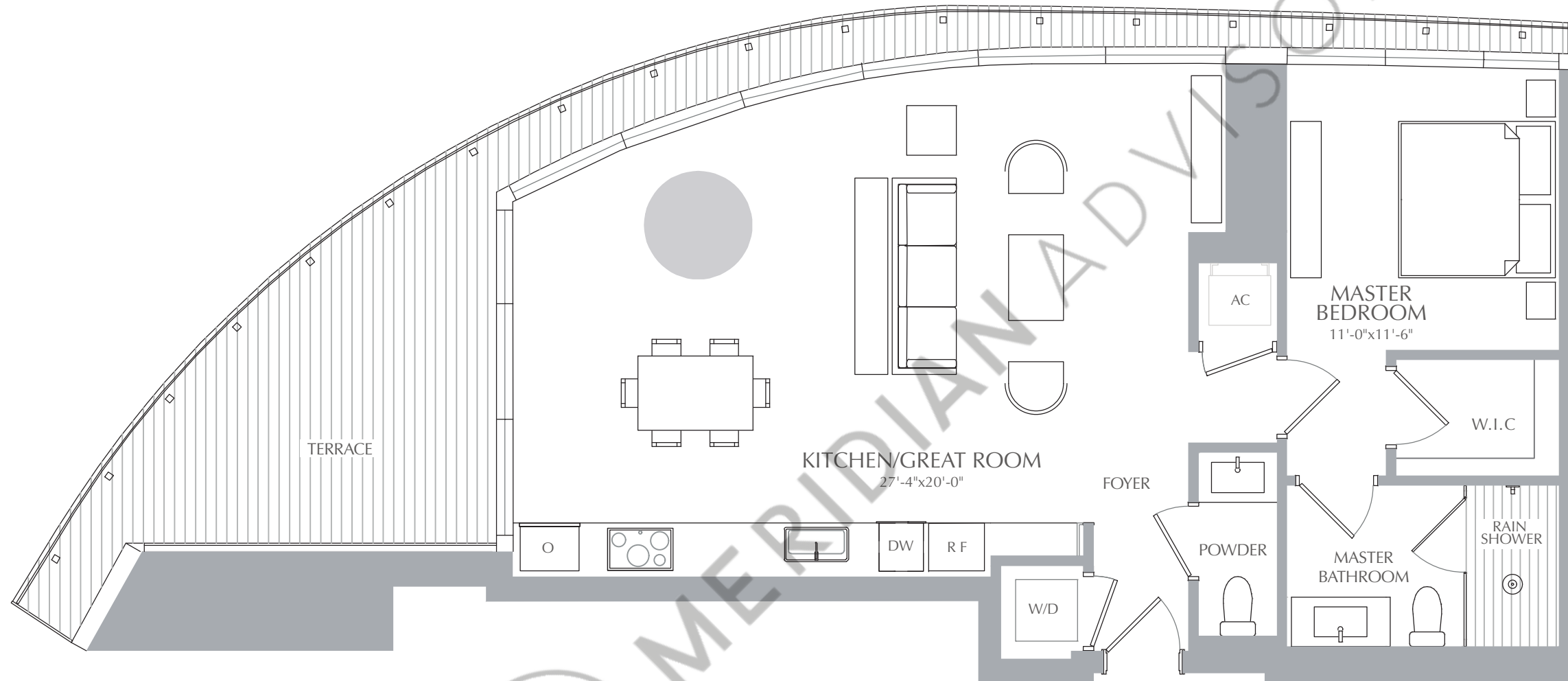
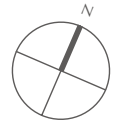

ORAL REPRESENTATIONS CANNOT BE RELIED UPON AS CORRECTLY STATING THE REPRESENTATIONS OF THE DEVELOPER. FOR CORRECT REPRESENTATIONS, MAKE REFERENCE TO THIS BROCHURE AND TO THE DOCUMENTS REQUIRED BY SECTION 718.503, FLORIDA STATUTES, TO BE FURNISHED BY A DEVELOPER TO A BUYER OR LESSEE. THESE MATERIALS ARE NOT INTENDED TO BE AN OFFER TO SELL, OR SOLICITATION TO BUY A UNIT IN THE CONDOMINIUM. SUCH AN OFFERING SHALL ONLY BE MADE PURSUANT TO THE PROSPECTUS (OFFERING CIRCULAR) FOR THE CONDOMINIUM AND NO STATEMENTS SHOULD BE RELIED UPON UNLESS MADE IN THE PROSPECTUS OR IN THE APPLICABLE PURCHASE AGREEMENT. IN NO EVENT SHALL ANY SOLICITATION, OFFER OR SALE OF A UNIT IN THE CONDOMINIUM BE MADE IN, OR TO RESIDENTS OF, ANY STATE OR COUNTRY IN WHICH SUCH ACTIVITY WOULD BE UNLAWFUL. Stated square footages and dimensions are measured to the exterior boundaries of the exterior walls and the centerline of interior demising walls and in fact vary from the square footage and dimensions that would be determined by using the description and definition of the "Unit" set forth in the declaration (which generally only includes the interior airspace between the perimeter walls and excludes all interior structural components and other common elements). This method is generally used in sales materials and is provided to allow a prospective buyer to compare the units with units in other condominium projects that utilize the same method. For your reference, the area of the unit, determined in accordance with these defined unit boundaries, is set forth in exhibit "3" to the declaration. Measurements of rooms set forth on this floor plan are generally taken at the farthest points of each given room (as if the room were a perfect rectangle), without regard for any cutouts or variations. Accordingly, the area of the actual room will typically be smaller than the product obtained by multiplying the stated length and width. All dimensions are estimates which will vary with actual construction, and all floor plans, specifications and other development plans are subject to change and will not necessarily accurately reflect the final plans and specifications for the development. All depictions of appliances, counters, soffits, floor coverings and other matters of detail, including, without limitation, items of finish and decoration, are conceptual only and are not necessarily included in each unit.

SKY RESIDENCES  
**RESIDENCES 08**  
 LEVEL 48

1 BEDROOM  
 1.5 BATHROOMS

INTERIOR: 972 SQ. FT. 90 SQ. M.  
 EXTERIOR: 142 SQ. FT. 13 SQ. M.  
 TOTAL: 1,114 SQ. FT. 103 SQ. M.



ASTON MARTIN

RESIDENCES

at  
 300 BISCAYNE BOULEVARD WAY  
 MIAMI

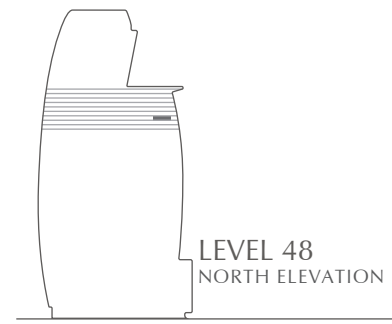
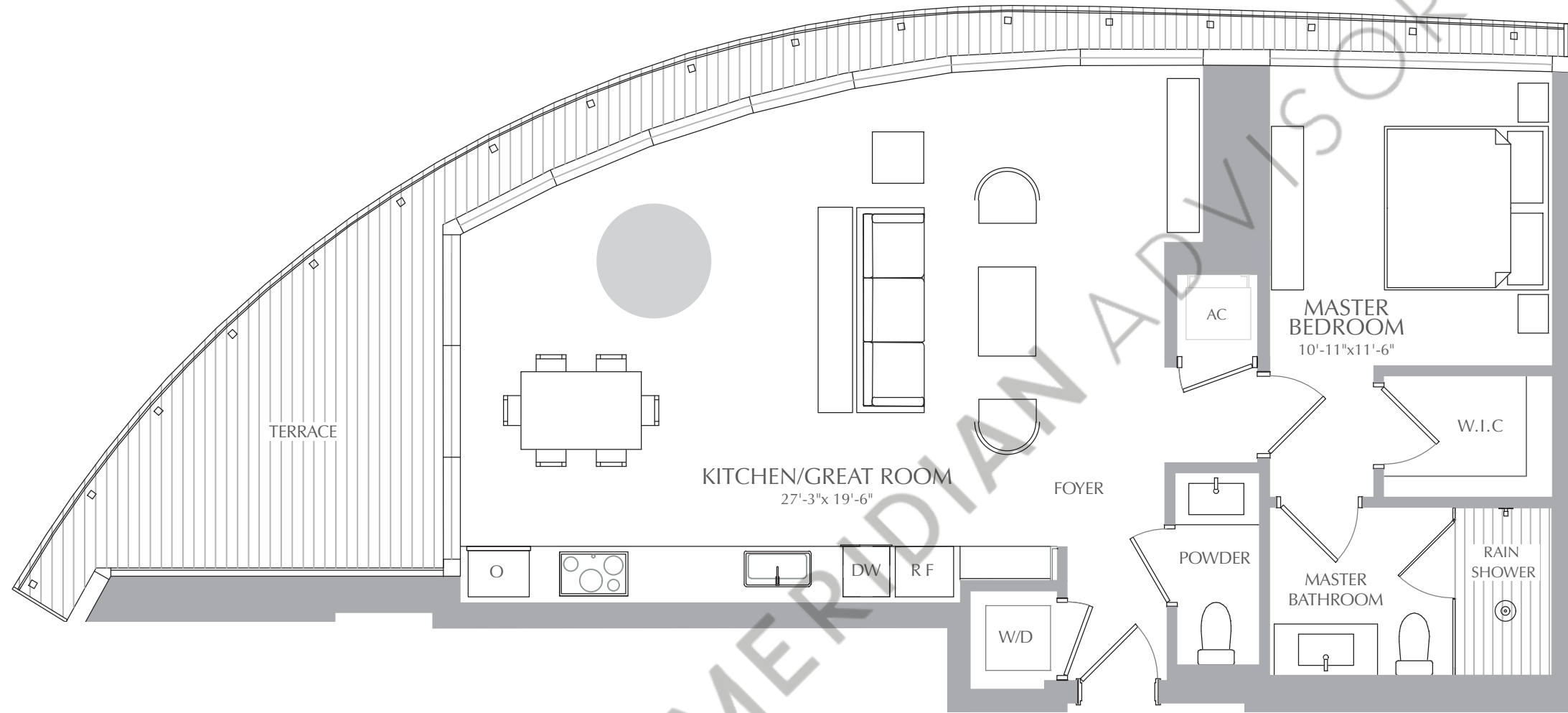
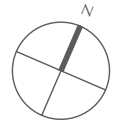

**ORAL REPRESENTATIONS CANNOT BE RELIED UPON AS CORRECTLY STATING THE REPRESENTATIONS OF THE DEVELOPER. FOR CORRECT REPRESENTATIONS, MAKE REFERENCE TO THIS BROCHURE AND TO THE DOCUMENTS REQUIRED BY SECTION 718.503, FLORIDA STATUTES, TO BE FURNISHED BY A DEVELOPER TO A BUYER OR LESSEE. THESE MATERIALS ARE NOT INTENDED TO BE AN OFFER TO SELL, OR SOLICITATION TO BUY A UNIT IN THE CONDOMINIUM. SUCH AN OFFERING SHALL ONLY BE MADE PURSUANT TO THE PROSPECTUS (OFFERING CIRCULAR) FOR THE CONDOMINIUM AND NO STATEMENTS SHOULD BE RELIED UPON UNLESS MADE IN THE PROSPECTUS OR IN THE APPLICABLE PURCHASE AGREEMENT. IN NO EVENT SHALL ANY SOLICITATION, OFFER OR SALE OF A UNIT IN THE CONDOMINIUM BE MADE IN, OR TO RESIDENTS OF, ANY STATE OR COUNTRY IN WHICH SUCH ACTIVITY WOULD BE UNLAWFUL.** Stated square footages and dimensions are measured to the exterior boundaries of the exterior walls and the centerline of interior demising walls and in fact vary from the square footage and dimensions that would be determined by using the description and definition of the "Unit" set forth in the declaration (which generally only includes the interior airspace between the perimeter walls and excludes all interior structural components and other common elements). This method is generally used in sales materials and is provided to allow a prospective buyer to compare the units with units in other condominium projects that utilize the same method. For your reference, the area of the unit, determined in accordance with these defined unit boundaries, is set forth in exhibit "3" to the declaration. Measurements of rooms set forth on this floor plan are generally taken at the farthest points of each given room (as if the room were a perfect rectangle), without regard for any cutouts or variations. Accordingly, the area of the actual room will typically be smaller than the product obtained by multiplying the stated length and width. All dimensions are estimates which will vary with actual construction, and all floor plans, specifications and other development plans are subject to change and will not necessarily accurately reflect the final plans and specifications for the development. All depictions of appliances, counters, soffits, floor coverings and other matters of detail, including, without limitation, items of finish and decoration, are conceptual only and are not necessarily included in each unit.

SKY RESIDENCES  
**RESIDENCES 08**  
 LEVEL 49

1 BEDROOM  
 1.5 BATHROOMS

INTERIOR: 956 SQ. FT. 89 SQ. M.  
 EXTERIOR: 116 SQ. FT. 11 SQ. M.  
 TOTAL: 1,072 SQ. FT. 100 SQ. M.



ASTON MARTIN

RESIDENCES

at  
 300 BISCAYNE BOULEVARD WAY  
 MIAMI

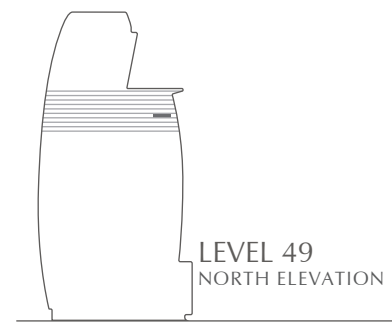
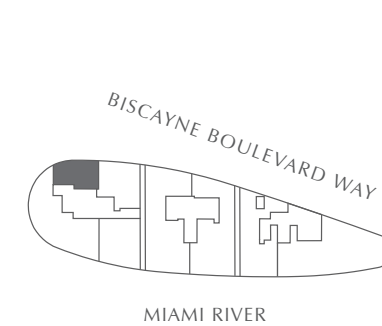
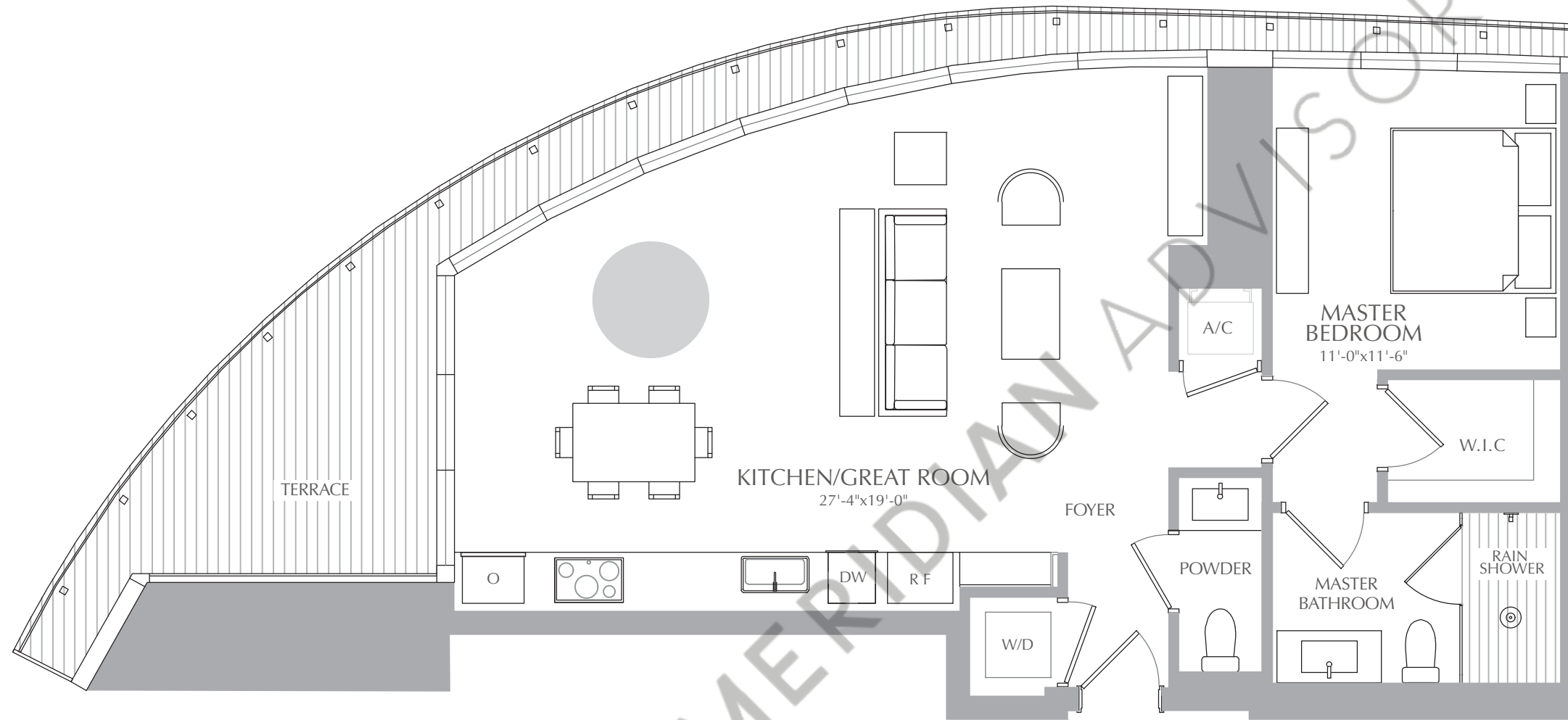
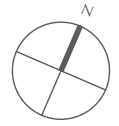

ORAL REPRESENTATIONS CANNOT BE RELIED UPON AS CORRECTLY STATING THE REPRESENTATIONS OF THE DEVELOPER. FOR CORRECT REPRESENTATIONS, MAKE REFERENCE TO THIS BROCHURE AND TO THE DOCUMENTS REQUIRED BY SECTION 718.503, FLORIDA STATUTES, TO BE FURNISHED BY A DEVELOPER TO A BUYER OR LESSEE. THESE MATERIALS ARE NOT INTENDED TO BE AN OFFER TO SELL, OR SOLICITATION TO BUY A UNIT IN THE CONDOMINIUM. SUCH AN OFFERING SHALL ONLY BE MADE PURSUANT TO THE PROSPECTUS (OFFERING CIRCULAR) FOR THE CONDOMINIUM AND NO STATEMENTS SHOULD BE RELIED UPON UNLESS MADE IN THE PROSPECTUS OR IN THE APPLICABLE PURCHASE AGREEMENT. IN NO EVENT SHALL ANY SOLICITATION, OFFER OR SALE OF A UNIT IN THE CONDOMINIUM BE MADE IN, OR TO RESIDENTS OF, ANY STATE OR COUNTRY IN WHICH SUCH ACTIVITY WOULD BE UNLAWFUL. Stated square footages and dimensions are measured to the exterior boundaries of the exterior walls and the centerline of interior demising walls and in fact vary from the square footage and dimensions that would be determined by using the description and definition of the "Unit" set forth in the declaration (which generally only includes the interior airspace between the perimeter walls and excludes all interior structural components and other common elements). This method is generally used in sales materials and is provided to allow a prospective buyer to compare the units with units in other condominium projects that utilize the same method. For your reference, the area of the unit, determined in accordance with these defined unit boundaries, is set forth in exhibit "3" to the declaration. Measurements of rooms set forth on this floor plan are generally taken at the farthest points of each given room (as if the room were a perfect rectangle), without regard for any cutouts or variations. Accordingly, the area of the actual room will typically be smaller than the product obtained by multiplying the stated length and width. All dimensions are estimates which will vary with actual construction, and all floor plans, specifications and other development plans are subject to change and will not necessarily accurately reflect the final plans and specifications for the development. All depictions of appliances, counters, soffits, floor coverings and other matters of detail, including, without limitation, items of finish and decoration, are conceptual only and are not necessarily included in each unit.

SKY RESIDENCES  
**RESIDENCES 08**  
 LEVEL 50

1 BEDROOM  
 1.5 BATHROOMS

INTERIOR: 928 SQ. FT. 86 SQ. M.  
 EXTERIOR: 95 SQ. FT. 9 SQ. M.  
 TOTAL: 1,023 SQ. FT. 95 SQ. M.



ASTON MARTIN

RESIDENCES

at  
 300 BISCAYNE BOULEVARD WAY  
 MIAMI

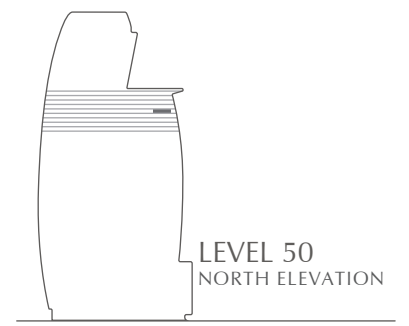
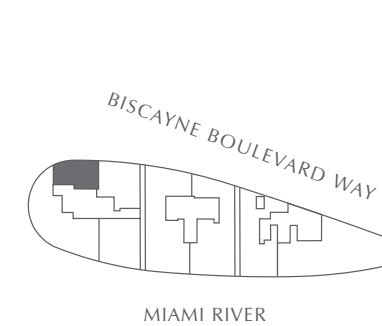
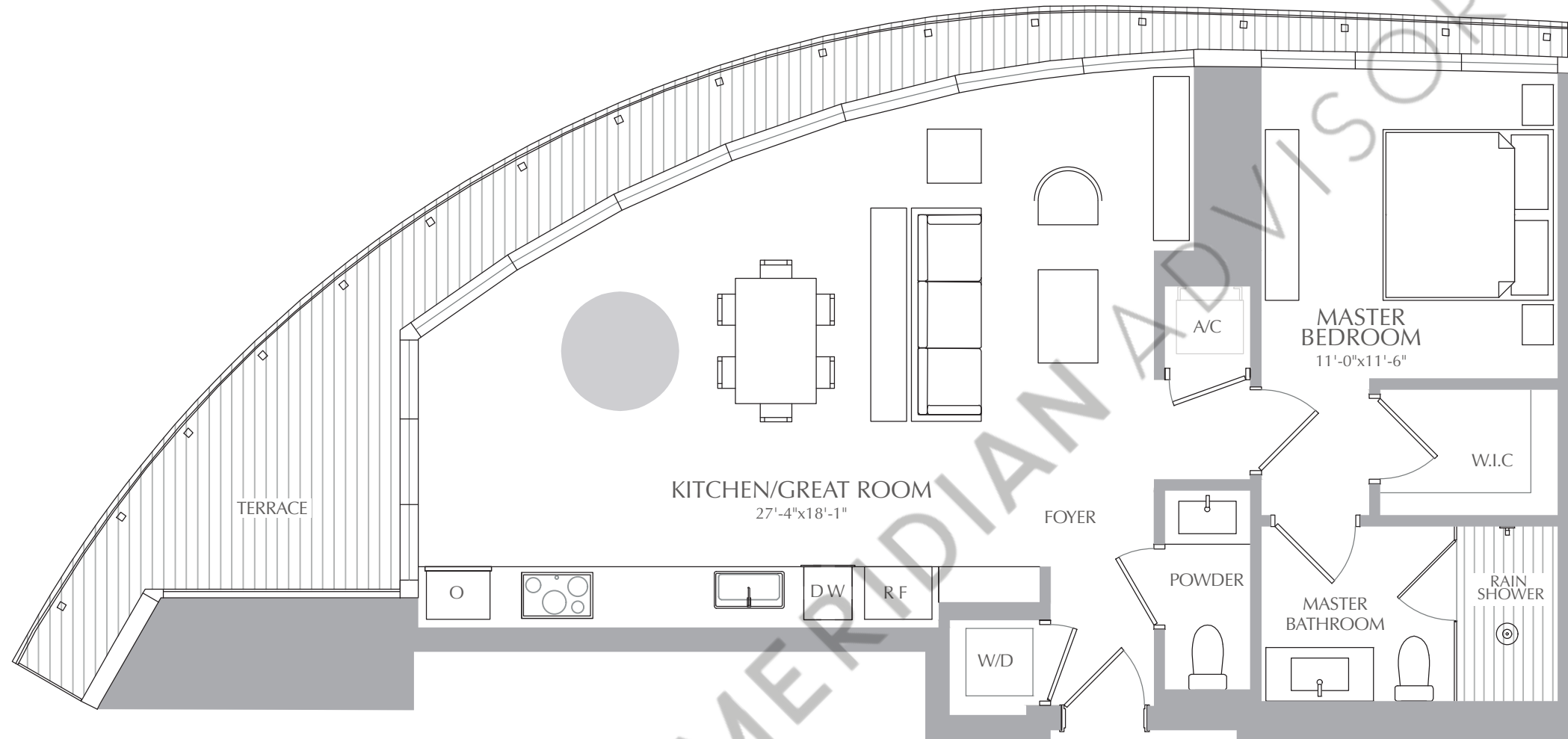
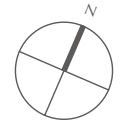

ORAL REPRESENTATIONS CANNOT BE RELIED UPON AS CORRECTLY STATING THE REPRESENTATIONS OF THE DEVELOPER. FOR CORRECT REPRESENTATIONS, MAKE REFERENCE TO THIS BROCHURE AND TO THE DOCUMENTS REQUIRED BY SECTION 718.503, FLORIDA STATUTES, TO BE FURNISHED BY A DEVELOPER TO A BUYER OR LESSEE. THESE MATERIALS ARE NOT INTENDED TO BE AN OFFER TO SELL, OR SOLICITATION TO BUY A UNIT IN THE CONDOMINIUM. SUCH AN OFFERING SHALL ONLY BE MADE PURSUANT TO THE PROSPECTUS (OFFERING CIRCULAR) FOR THE CONDOMINIUM AND NO STATEMENTS SHOULD BE RELIED UPON UNLESS MADE IN THE PROSPECTUS OR IN THE APPLICABLE PURCHASE AGREEMENT. IN NO EVENT SHALL ANY SOLICITATION, OFFER OR SALE OF A UNIT IN THE CONDOMINIUM BE MADE IN, OR TO RESIDENTS OF, ANY STATE OR COUNTRY IN WHICH SUCH ACTIVITY WOULD BE UNLAWFUL. Stated square footages and dimensions are measured to the exterior boundaries of the exterior walls and the centerline of interior demising walls and in fact vary from the square footage and dimensions that would be determined by using the description and definition of the "Unit" set forth in the declaration (which generally only includes the interior airspace between the perimeter walls and excludes all interior structural components and other common elements). This method is generally used in sales materials and is provided to allow a prospective buyer to compare the units with units in other condominium projects that utilize the same method. For your reference, the area of the unit, determined in accordance with these defined unit boundaries, is set forth in exhibit "3" to the declaration. Measurements of rooms set forth on this floor plan are generally taken at the farthest points of each given room (as if the room were a perfect rectangle), without regard for any cutouts or variations. Accordingly, the area of the actual room will typically be smaller than the product obtained by multiplying the stated length and width. All dimensions are estimates which will vary with actual construction, and all floor plans, specifications and other development plans are subject to change and will not necessarily accurately reflect the final plans and specifications for the development. All depictions of appliances, counters, soffits, floor coverings and other matters of detail, including, without limitation, items of finish and decoration, are conceptual only and are not necessarily included in each unit.



SKY RESIDENCES  
**RESIDENCES 08**  
 LEVEL 51

1 BEDROOM  
 1.5 BATHROOMS

INTERIOR: 934 SQ. FT. 87 SQ. M.  
 EXTERIOR: 0 SQ. FT. 0 SQ. M.  
 TOTAL: 934 SQ. FT. 87 SQ. M.



ASTON MARTIN

RESIDENCES

at  
 300 BISCAYNE BOULEVARD WAY  
 MIAMI

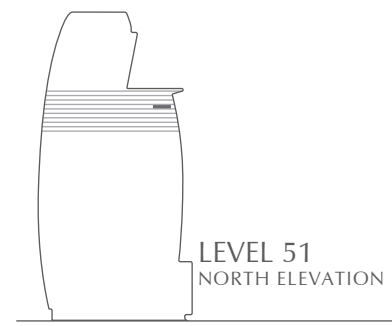
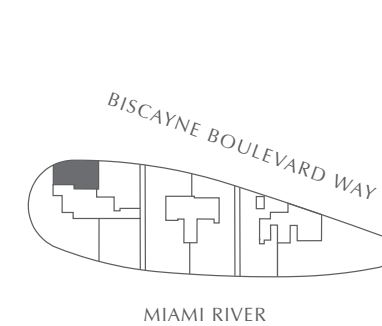
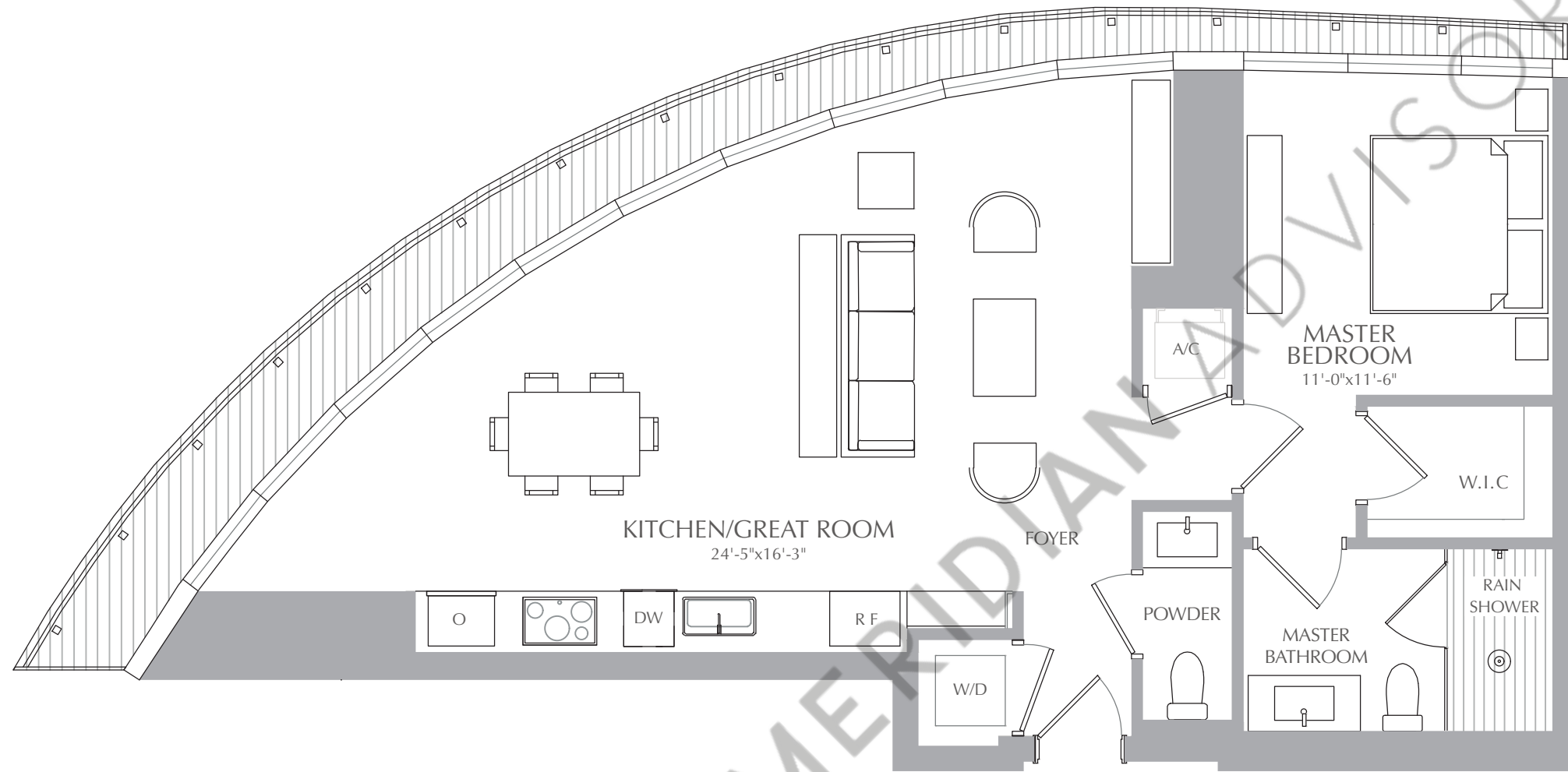
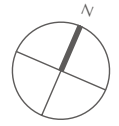

ORAL REPRESENTATIONS CANNOT BE RELIED UPON AS CORRECTLY STATING THE REPRESENTATIONS OF THE DEVELOPER. FOR CORRECT REPRESENTATIONS, MAKE REFERENCE TO THIS BROCHURE AND TO THE DOCUMENTS REQUIRED BY SECTION 718.503, FLORIDA STATUTES, TO BE FURNISHED BY A DEVELOPER TO A BUYER OR LESSEE. THESE MATERIALS ARE NOT INTENDED TO BE AN OFFER TO SELL, OR SOLICITATION TO BUY A UNIT IN THE CONDOMINIUM. SUCH AN OFFERING SHALL ONLY BE MADE PURSUANT TO THE PROSPECTUS (OFFERING CIRCULAR) FOR THE CONDOMINIUM AND NO STATEMENTS SHOULD BE RELIED UPON UNLESS MADE IN THE PROSPECTUS OR IN THE APPLICABLE PURCHASE AGREEMENT. IN NO EVENT SHALL ANY SOLICITATION, OFFER OR SALE OF A UNIT IN THE CONDOMINIUM BE MADE IN, OR TO RESIDENTS OF, ANY STATE OR COUNTRY IN WHICH SUCH ACTIVITY WOULD BE UNLAWFUL. Stated square footages and dimensions are measured to the exterior boundaries of the exterior walls and the centerline of interior demising walls and in fact vary from the square footage and dimensions that would be determined by using the description and definition of the "Unit" set forth in the declaration (which generally only includes the interior airspace between the perimeter walls and excludes all interior structural components and other common elements). This method is generally used in sales materials and is provided to allow a prospective buyer to compare the units with units in other condominium projects that utilize the same method. For your reference, the area of the unit, determined in accordance with these defined unit boundaries, is set forth in exhibit "3" to the declaration. Measurements of rooms set forth on this floor plan are generally taken at the farthest points of each given room (as if the room were a perfect rectangle), without regard for any cutouts or variations. Accordingly, the area of the actual room will typically be smaller than the product obtained by multiplying the stated length and width. All dimensions are estimates which will vary with actual construction, and all floor plans, specifications and other development plans are subject to change and will not necessarily accurately reflect the final plans and specifications for the development. All depictions of appliances, counters, soffits, floor coverings and other matters of detail, including, without limitation, items of finish and decoration, are conceptual only and are not necessarily included in each unit.

SKY RESIDENCES  
**RESIDENCES 08**  
 LEVEL 52

1 BEDROOM  
 1.5 BATHROOMS

INTERIOR: 894 SQ. FT. 83 SQ. M.  
 EXTERIOR: 0 SQ. FT. 0 SQ. M.  
 TOTAL: 894 SQ. FT. 83 SQ. M.



ASTON MARTIN

RESIDENCES

at  
 300 BISCAYNE BOULEVARD WAY  
 MIAMI

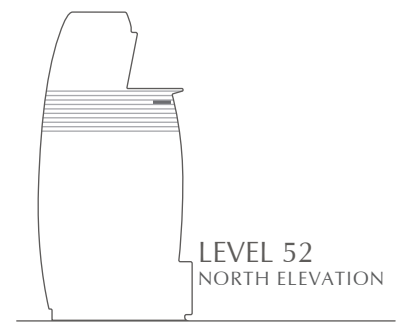
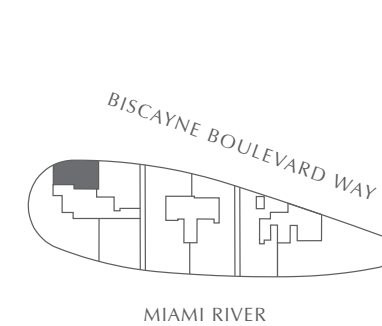
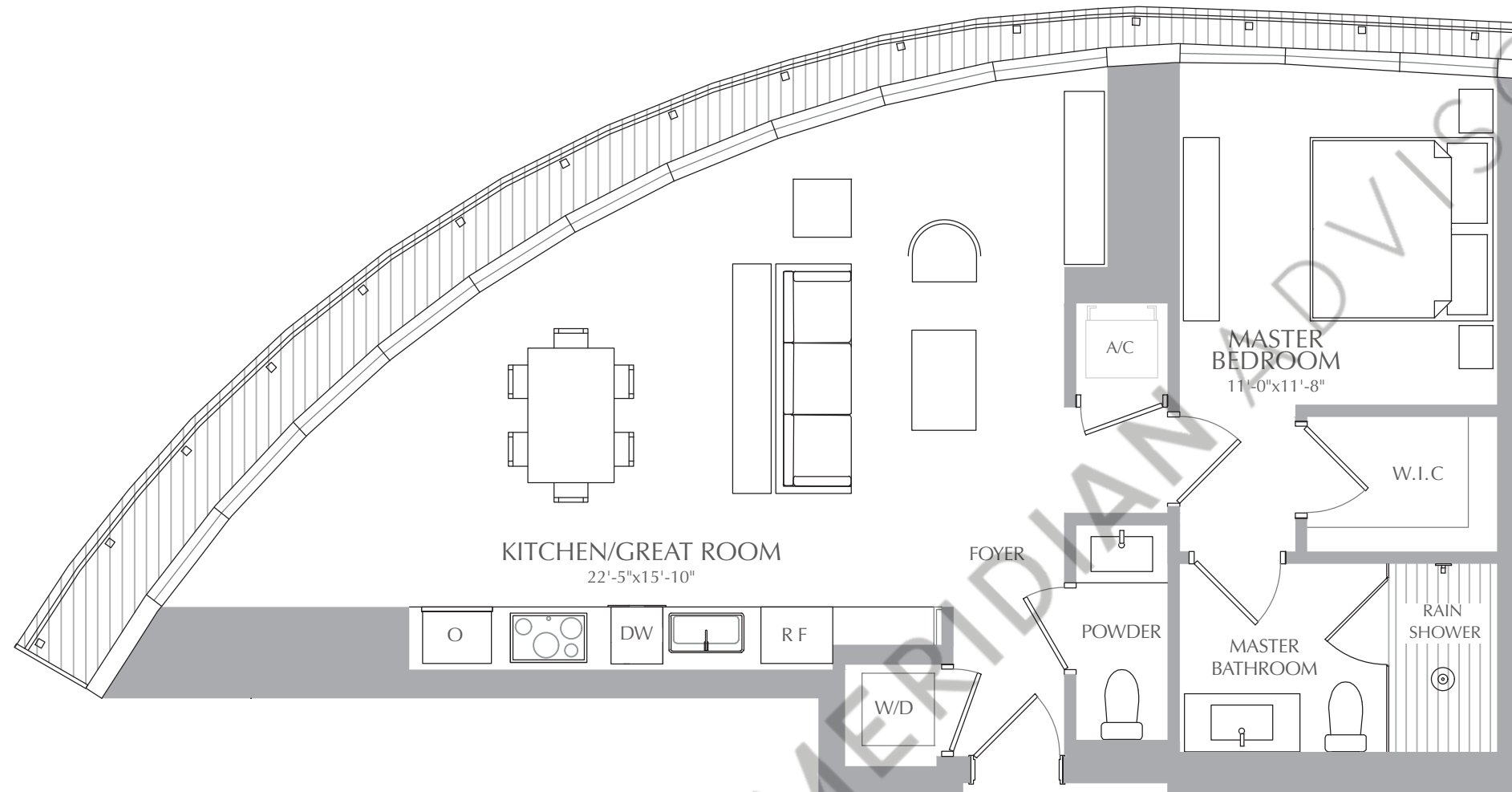
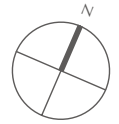

ORAL REPRESENTATIONS CANNOT BE RELIED UPON AS CORRECTLY STATING THE REPRESENTATIONS OF THE DEVELOPER. FOR CORRECT REPRESENTATIONS, MAKE REFERENCE TO THIS BROCHURE AND TO THE DOCUMENTS REQUIRED BY SECTION 718.503, FLORIDA STATUTES, TO BE FURNISHED BY A DEVELOPER TO A BUYER OR LESSEE. THESE MATERIALS ARE NOT INTENDED TO BE AN OFFER TO SELL, OR SOLICITATION TO BUY A UNIT IN THE CONDOMINIUM. SUCH AN OFFERING SHALL ONLY BE MADE PURSUANT TO THE PROSPECTUS (OFFERING CIRCULAR) FOR THE CONDOMINIUM AND NO STATEMENTS SHOULD BE RELIED UPON UNLESS MADE IN THE PROSPECTUS OR IN THE APPLICABLE PURCHASE AGREEMENT. IN NO EVENT SHALL ANY SOLICITATION, OFFER OR SALE OF A UNIT IN THE CONDOMINIUM BE MADE IN, OR TO RESIDENTS OF, ANY STATE OR COUNTRY IN WHICH SUCH ACTIVITY WOULD BE UNLAWFUL. Stated square footages and dimensions are measured to the exterior boundaries of the exterior walls and the centerline of interior demising walls and in fact vary from the square footage and dimensions that would be determined by using the description and definition of the "Unit" set forth in the declaration (which generally only includes the interior airspace between the perimeter walls and excludes all interior structural components and other common elements). This method is generally used in sales materials and is provided to allow a prospective buyer to compare the units with units in other condominium projects that utilize the same method. For your reference, the area of the unit, determined in accordance with these defined unit boundaries, is set forth in exhibit "3" to the declaration. Measurements of rooms set forth on this floor plan are generally taken at the farthest points of each given room (as if the room were a perfect rectangle), without regard for any cutouts or variations. Accordingly, the area of the actual room will typically be smaller than the product obtained by multiplying the stated length and width. All dimensions are estimates which will vary with actual construction, and all floor plans, specifications and other development plans are subject to change and will not necessarily accurately reflect the final plans and specifications for the development. All depictions of appliances, counters, soffits, floor coverings and other matters of detail, including, without limitation, items of finish and decoration, are conceptual only and are not necessarily included in each unit.